

Elcometer 456 Coating Thickness Gauge



Elcometer 456 Coating Thickness Gauge

Elcometer 456 Coating Thickness Gauge

With its recently enhanced and simplified menu screen options, the Elcometer 456 remains the most advanced hand held coating thickness gauge on the market today.

This flagship product is available in any combination of Basic, Standard, and Top functionality; together with Integral (built in) and an extensive range of separate plug in probes.

With such an extensive range of gauge options, there is an Elcometer 456 to meet your specific application needs.

In this section the Elcometer 456 Range is explained as follows:

At a glance

- Fast, accurate & easy to use Paint & Coating Thickness Gauge.
- Available as an integral or separate probe version.
- Menu driven display with all calibration & on screen instructions in 25 languages.
- 3 versions available - basic, standard & top - to meet your specific requirements.

- Gauge Features
- Integral Gauges and Options
- Separate Gauges
- Range of Separate Probe Options
 - Standard
 - Miniature
 - Plug in Probes (PINIP™)

Coating Thickness Gauges-Digital

Simple to interpret, small and portable gauges for the measurement of coatings on all metal surfaces. Digital coating thickness gauges are more accurate, more repeatable and more reproducible than any other type of coating thickness gauge on the market today.

Elcometer offers the world's most comprehensive range of portable digital coating thickness gauges - for measurements on either Ferrous substrates (F), Non-Ferrous substrates (NF), or on both Ferrous and Non-Ferrous (FNF), Elcometer can provide you with a gauge to meet your need.

With a wide choice of gauges to choose from, the User needs to understand the terminology of Coating Thickness Gauges or, 'The Language of CTGs'.

THE LANGUAGE OF CTGs

In selecting the most appropriate gauge for your application, you need to answer specific questions.

1. What is the substrate (the surface metal) you are coating/inspecting?

Is the metal a Ferrous Substrate (F) or a Non-Ferrous (NF)? Sometimes this is difficult to answer – the substrate may have already been coated. The easiest way to identify this is to see if a magnet will stick to the surface. If it does, then the substrate will be Ferrous, if it does not, then the substrate is Non-Ferrous.

2. Do you measure only on this substrate?

If you only inspect one type of product, then the answer is yes. If you have a range of products that you inspect, then you need to consider whether they are all of the same type of substrate. You should also consider if you have a future possibility of inspecting other substrates. If so, you should consider an FNF gauge.

Can be used in accordance with:		
FERROUS (F)	NON-FERROUS (NF)	DUAL FERROUS and NON-FERROUS (FNF)
ASTM B 499 BS 5411-11 BS 3900-C5-6Aa BS EN ISO 1461 DIN 50981 ISO 2178 ISO 2808-6Aa prEN ISO 19840	ASTM D 1400 ASTM B 244 BS 5411-3 BS 3900-C5-6Ba BS 5599 DIN 50984 ISO 2360 ISO 2808-6Ba	All of the Ferrous and Non-Ferrous List plus; ASTM E 376

ELCOMETER 456 GAUGE FEATURES			
	Basic	Standard	Top
Fully Interchangeable Separate Probe Option	•	•	•
Menu driven display	•	•	•
User switchable Normal / Extended menu options	•	•	•
On-screen Help function	•	•	•
User switchable Metric / Imperial units	•	•	•
On-screen calibration instructions in 25 languages	•	•	•
Calibration options (stated):			
- smooth, 2 point, rough surfaces and special substrate	•	•	•
- zero offset* (subtracts a fixed value from reading)	•	•	•
- ISO, SSPC, Swedish and Australian predefined		•	•
Backlight for measurement in dark areas	•	•	•
Infrared data output	•	•	•
Immediate data output	•	•	•
Batch data output		•	•
Cable data output to PC		•	•
Free PC software and download cable (RS232)		•	•
Statistics (from single readings or within batches)			
- Number of readings, mean, standard deviation, coefficient of variation, highest and lowest readings	•	•	•
Readings memory		250 readings in one batch	40,000 in up to 999 batches
Individual reading review		•	•
Individual batch calibrations			•
Reading limits (high and low values can be set by the User)		•	•
Clock and Alarm – prompt to take next reading			•
Date and time stamp on print outs			•
* Zero Offset, USA patent Number 6243661			

ELCOMETER 456 GAUGE SPECIFICATIONS	
Measurement Speed	Greater than 60 readings per minute
Display	STN Graphics (LCD), 128 x 64 pixels; 19.8 x 39.6mm (0.78" x 1.56")
Battery Type	2 x AAA (LR03) Rechargeable batteries can be used
Battery Life	30 - 40 hours continuous use with alkaline dry batteries. (15,000 - 20,000 readings at an average of 8 readings per minute).
Minimum Substrate Thick-	300 microns (12 mils) unless special calibration adjustment is
Measurement Options	Ferrous (F), Non Ferrous (NF) and Dual (FNF)
Operating Temperature	0 - 50°C (32 - 120°F)
Dimensions	128 x 68 x 28mm (5.0" x 2.7" x 1.1")
Weight (incl. Dry Batteries)	130g (4.58oz)

3. What is your Coating / Substrate Combination?

Ensure compatibility of the coating and substrate; whether a coating thickness gauge will provide an accurate reading.

4. Typically what sort of coating thickness do you need to measure?

This will help you select the correct probe scale range - e.g. Scale 1 measures coatings up to 1500µm (60mils).

5. What type of probe do you need?

Depending on your application you can select from:

- Integral Probe (the probe is built into the gauge for accurate single handed measurements on large surface areas, pipes, etc.)
- Separate Probe (the probe is connected to the gauge by a cable for all applications).
- PINIP™ (the separate probe is directly attached to the base of the instrument – providing, in your separate gauge, all the benefits of an integral unit).

Separate Probes can be selected from our wide range to meet your application requirements. These include:

- *Regular Probes:* Including Straight, Right Angle (90°) and Telescopic options
- *Miniature Probes:* Including Straight, Right Angle (90°), 45° Angle all in either long or short versions.

6. Do you need to save your readings for your ISO records, or as proof of inspection to your customer?

Elcometer gauges are available in three options:

- *Basic Gauge* -with simple statistics but no memory or data output
- *Standard Gauge* -with statistics, limited memory and data output
- *Top Gauge* -with statistics, enhanced memory, batching capability and data output.

Integral Gauge Options



Elcometer 456 Integral Gauge

Elcometer 456 Integral Gauge Options

The Elcometer 456 Integral (built in) Probes offer an ideal gauge for flat or uneven surfaces alike. Their large 'Bigfoot™' probe allows for consistent and repeatable results as there is no cable, the gauge can take readings using one hand.

The Elcometer 456 Integral Gauges are ideal for measurement on both organic and inorganic coatings and are available in either:

- Ferrous (F),
- Non-Ferrous (NF), or
- Both Ferrous and Non-Ferrous (FNF)

At a glance

- *Single handed operation.*
- *Wide footprint to give greater stability, accuracy & repeatability of readings.*
- *Ideal for flat & curved surfaces.*
- *Can be used on smooth & blast profiled substrates.*
- *Wide range of thickness scales available.*

ELCOMETER 456 INTEGRAL GAUGE - SPECIFICATIONS AND PART NUMBERS

		Metric	Imperial	Part Number
BASIC	Ferrous Basic Integral Scale 1	0 – 1500µm	0 – 60 mils	A456FBI1
	Ferrous Basic Integral Scale 2	0 – 5mm	0 – 200 mils	A456FBI2
	Ferrous Basic Integral Scale 1 2* - High Resolution	0 – 5mm	0 – 200 mils	A456FBI12
	Ferrous Basic Integral Scale 3	0 – 13mm	0 – 500 mils	A456FBI3
	Non-Ferrous Basic Integral	0 – 1500µm	0 – 60 mils	A456NBI1
	Dual Basic Integral FNF	0 – 1500µm	0 – 60 mils	A456FNFB11
STANDARD	Ferrous Standard Integral Scale 1	0 – 1500µm	0 – 60 mils	A456FS11
	Ferrous Standard Integral Scale 2	0 – 5mm	0 – 200 mils	A456FS12
	Ferrous Standard Integral Scale 1 2* - High Resolution	0 – 5mm	0 – 200 mils	A456FBS112
	Ferrous Standard Integral Scale 3	0 – 13mm	0 – 500 mils	A456FS13
	Non-Ferrous Standard Integral	0 – 1500µm	0 – 60 mils	A456NS11
	Dual Basic Standard FNF	0 – 1500µm	0 – 60 mils	A456FNFS11
TOP	Ferrous Top Integral Scale 1	0 – 1500µm	0 – 60 mils	A456FT11
	Ferrous Top Integral Scale 2	0 – 5mm	0 – 200 mils	A456FT12
	Ferrous Top Integral Scale 1 2* - High Resolution	0 – 5mm	0 – 200 mils	A456FBT112
	Ferrous Top Integral Scale 3	0 – 13mm	0 – 500 mils	A456FT13
	Non-Ferrous Top Integral	0 – 1500µm	0 – 60 mils	A456NT11
	Dual Basic Top FNF	0 – 1500µm	0 – 60 mils	A456FNFT11

* The F1 2 Scale combines the F1 Scale and F2 Scale in a single probe (Patent applied for) with the user selecting the appropriate range (and hence resolution) for

Separate Gauge Options



Elcometer 456 Separate Gauge

Elcometer 456 Separate Gauge Options

The Elcometer 456 Separate (Plug in) Probe Option is the most versatile gauge for the measurement of a wide range of coatings on metal substrates.

- Available in Basic, Standard and Top Models.
- Available in Ferrous (F), Non-Ferrous (NF) & Dual FNF versions.

At a glance

- *A wide range of probes available for measurements in almost any environment.*
- *Fully interchangeable probes:*
 - *All Ferrous models will accept ANY Ferrous 456 probe*
 - *All Non-Ferrous models will accept ANY Non-Ferrous 456 probe*
 - *All Dual FNF models will accept ALL 456 probes*
- *Ideal for measuring coating thickness in small & large, smooth & curved, open air or confined environments.*

ELCOMETER 456 SEPARATE PART NUMBERS

	BASIC	STANDARD	TOP
Ferrous Separate	A456FBS	A456FSS	A456FTS
Non- Ferrous Separate	A456NBS	A456NSS	A456NTS
Dual FNF Separate	A456FNFBS	A456FNFSS	A456FNFSS

Probes for the Elcometer 456 Separate Gauges are supplied separately. Please remember to select the appropriate probe (s) from the Elcometer probes list on the following page

Separate Probe Types

A wide range of probe types and scale ranges are available for the Elcometer 456 separate gauge.



STANDARD PROBES (F, NF & FNF)

Available in Standard Right Angle or Telescopic options and are suitable for most coating thickness requirements.



PINIP™ PROBES (F, NF & FNF)

The Plug-In Integral Probe (PINIP™), has been designed to be screwed into the base of any separate Elcometer 456 gauge to transform their separate gauge into an integral unit for single handed operations. Its 'Bigfoot™' Probe gives greater stability on large surface areas.















Also available is a High Temperature version for measuring coatings on hot ferrous substrates up to 250° (480°F)



MINIATURE PROBES (F & NF)

Ideal for taking measurements in hard to reach places, on small surface areas and on concrete reinforcement bars. Miniature probes are available in Straight, Right Angle and 45° options. All miniature probes are available in either 45mm (1.77") or 150mm (5.90") probe lengths.

Standard Probe Options



Probe Type	Part Number	Measuring Range		Accuracy ¹		Resolution	
		Metric	Imperial	Metric	Imperial	Metric	Imperial
F1 Standard 	T456F1S	0-1500 µm	0-60 mils	±1-3% or ±2.5µm	±1-3% or ±0.1mil	0.1µm up to 100µm 1µm 100-1500µm	0.01mil up to 5mils 0.1mil 5-60mils
F1 Right Angle 	T456F1R						
F1 Telescopic 	T456F1T						
F2 Standard 	T456F2S	0-5mm	0-200 mils	±1-3% or ±0.02µm	±1-3% or ±1.0mils	1µm up to 1mm 10µm 1-5mm	0.01mil up to 50mils 1mil 50-200mils
F2 Right Angle 	T456F2R						
F2 Telescopic 	T456F2T						
F1 2 Standard 	T456F12S	0-1500µm	0-60 mils	±1-3% or ±2.5µm	±1-3% or ±0.1mil	0.1µm up to 100µm 1µm 100-1500µm	0.01mil up to 50mils 1mil 50-200mils
F1 2 Right Angle 	T456F12R	0-5mm	0-200 mils	±1-3% or ±0.02µm	±1-3% or ±1.0mils	1µm up to 1mm 10µm 1-5mm	0.01mil up to 50mils 1mil 50-200mils
F3 Standard 	T456F3S	0-13mm	0-500 mils	±1-3% or ±0.05µm	±1-3% or ±2.0mils	1µm up to 2mm 10µm 2-13mm	1mil up to 100mils 100-500mils
F6 Standard	T456F6S	0-25mm	0-	±1-3% or	±1-3% or	10µm up to 2mm	1mil up to 100mils 10mil
N1 Standard 	T456N1S	0-1500µm	0-60 mils	±1-3% or ±2.5µm	±1-3% or ±1.0mils	0.1µm up to 100µm 1µm 100-1500µm	0.01mil up to 5mils 0.1mil 5-60mils
N1 Right Angle 	T456N1R						
N1A Anodiser 	T456N1AS						
N2 Standard 	T456N2S	0-5mm	0-200 mils	±1-3% or ±0.02mm	±1-3% or ±1.0mil	1µm up to 1mm 10µm 1-5mm	0.01mil up to 50mils 1mil 50-200mils
N6 Standard	T456N6S	0-30mm	0- 1200mils	±1-3% or ±0.05mm	±1-3% or ±1.0mil	10µm up to 2mm 100µm 2-30mm	1mil up to 100mils 10mil 100-1200mils
FNF1 Standard 	T456FNF1S	0-1500µm	0-60 mils	±1-3% or ±2.5µm	±1-3% or ±0.1mil	0.1µm up to 100µm 1µm 100-1500µm	0.01mil up to 5mils 0.1mil 5-60mils
FNF1 Right Angle 	T456FNF1R						

¹ Accuracy: ±1% when calibrated close to the required thickness, ±3% across the range





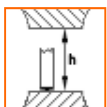
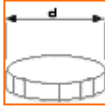

Standard Probe Specifications

Operating Temperature	0 to 50°C (32 to 120°F) *	
Storage Temperature	-10 to 60°C (14 to 140°F)	
Minimum Substrate Thickness	Ferrous – 0.3mm (12 mils)	Non-Ferrous – 0.1mm (4 mils)

* Up to 80°C (176°F) for the N6 Standard Probe

Probe Type				
	Minimum Convex Surface Diameter	Minimum Concave Surface Radius	Headroom	Minimum Sample Diameter
F1 (or F1 2 set as F1)	4mm (0.16")	25mm (0.98")	85mm (3.35")	4mm (0.16")
F2 (or F1 2 set as F2)	4mm (0.16")	25mm (0.98")	89mm (3.50")	8mm (0.32")
F1 Right Angle (or F1 2 set as F1)	4mm (0.16")	25mm (0.98")	28mm (1.10")	4mm (0.16")
F2 Right Angle (or F1 2 set as F2)	4mm (0.16")	25mm (0.98")	32mm (1.26")	8mm (0.32")
F1 Telescopic	4mm (0.16")	25mm (0.98")	32mm (1.26")	4mm (0.16")
F2 Telescopic	4mm (0.16")	25mm (0.98")	36mm (1.42")	8mm (0.32")
F3 Standard	15mm (0.59")	40mm (1.57")	102mm (4.02")	14mm (0.55")
F6 Standard	35mm (1.4")	170mm (6.7")	150mm (5.9")	51mm (2")
N1	35mm (1.38")	25mm (0.98")	85mm (3.35")	6mm (0.24")
N1 Right Angle	35mm (1.38")	25mm (0.98")	28mm (1.10")	6mm (0.24")
N1A Anodiser's Probe	35mm (1.38")	25mm (0.98")	85mm (3.35")	6mm (0.24")
N2 Standard	100mm (3.97")	150mm (5.90")	85mm (3.35")	14mm (0.55")
N6 Standard	n/a	400mm (15.8")	160mm (6.3")	58mm (2.3")
FNF1 (N mode)	38mm (1.50")	25mm (0.98")	88mm (3.46")	8mm (0.32")
FNF1 (F mode)	4mm (0.16 ")	25mm (0.98")	88mm (3.46")	4mm (0.16")
FNF1 Right Angle (N mode)	38mm (1.50")	25mm (0.98")	34mm (1.34")	8mm (0.32")
FNF1 Right Angle (F mode)	4mm (0.16 ")	25mm (0.98")	34mm (1.34")	4mm (0.16")



PINIP™ Probe Options

Probe Type	Part Number	Measuring Range		Accuracy ¹		Resolution	
		Metric	Imperial	Metric	Imperial	Metric	Imperial
F1 PINIP™ 	T456F1P	0 – 1500µm	0 – 60 mils	±1-3% or ±2.5µm	±1-3% or ±0.1mils	0.10µm up to 100µm 1µm 100–1500µm	0.01mils up to 5mils 0.1mils 5–60mils
F2 PINIP™ 	T456F2P	0 – 5mm	0 – 200 mils	±1-3% or ±0.02mm	±1-3% or ±1.0mils	1µm up to 1mm 10µm	0.1mils up to 50mils 1mils
F1 2 High Temp PINIP™ 	T456F12PHT	0 – 5mm	0 – 200 mils	±1-3% or ±0.02mm	±1-3% or ±1.0mils	1µm up to 1mm 10µm	0.1mils up to 50mils 1mils
F3 PINIP™ 	T456F3P	0 – 13mm	0 – 500 mils	±1-3% or ±0.05mm	±1-3% or ±2.0mils	1µm up to 2mm 10µm	0.1mils up to 100mils 1mils
N1 PINIP™ 	T456N1P	0 – 1500µm	0 – 60 mils	±1-3% or ±2.5µm	±1-3% or ±0.1mils	0.10µm up to 100µm 1µm 100–1500µm	0.01mils up to 5mils 0.1mils 5–60mils
FNF1 PINIP™ 	T456FNF1P	0 – 1500µm	0 – 60 mils	±1-3% or ±2.5µm	±1-3% or ±0.1mil	0.10µm up to 100µm 1µm	0.01mils up to 5mils 0.1mils





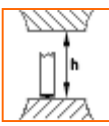
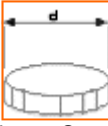

¹ Accuracy: ±1% when calibrated close to the required thickness, ±3% across the range

PINIP™ Probe Specifications

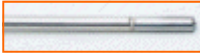
Operating Temperature	Up to 150°C (300°F) except for High Temp PINIP™ for temperatures up to 250°C (480°F)
Storage Temperature	-10 to 60°C (14 to 140°F)
Minimum Substrate Thickness	Ferrous – 0.3mm (12 mils) Non-Ferrous – 0.1mm (4 mils)

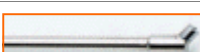
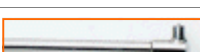
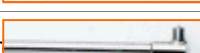
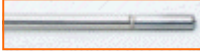
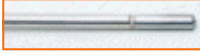
Probe Type	 Minimum Convex Surface Diameter	 Minimum Concave Surface Radius	 Headroom	 Minimum Sample Diameter
F1 (or F1 2 set as F1)	4mm (0.16")	60mm (2.36")	153mm (6.02")	4mm (0.16")
F2 (or F1 2 set as F2)	4mm (0.16")	60mm (2.36")	157mm (6.18")	8mm (0.32")
F3	15mm (0.59")	45mm (1.77")	168mm (6.61")	14mm (0.55")
N1	35mm (1.38")	50mm (1.97")	153mm (6.03")	6mm (0.24")
FNF1 (N mode)	38mm (1.50")	55mm (2.17")	154mm (6.06")	8mm (0.32")
FNF1 (F mode)	4mm (0.16")	55mm (2.17")	154mm (6.06")	4mm (0.16")

Miniature Probe Options

Probe Type	Part Number	Measuring Range		Accuracy ¹		Resolution		
		Metric	Imperial	Metric	Imperial	Metric	Imperial	
FERROUS MINIATURE PROBES								
FM3 Straight - 45mm	 T456FM3---A	0-500 µm	0-20 mils	±1-3% or ±2.5µm	±1-3% or ±0.1mil	0.1µm - 100µm 0.1µm 100 - 500µm 1µm	0 - 5mils 0.01mil 5 - 20mils 0.1mils	
FM3 Straight - 150mm	 T456FM3---C							
FM3 45° Angle- 45mm	 T456FM3R45A							
FM3 45° Angle- 150mm	 T456FM3R45C							
FM3 Right Angle - 45mm	 T456FM3R90A							
FM3 Right Angle - 150mm	 T456FM3R90C							
NON-FERROUS MINIATURE PROBES								
NM3 Straight - 45mm	 T456FNM3---A	0-500 µm	0-20 mils	±1-3% or ±2.5µm	±1-3% or ±0.1mil	0.1µm - 100µm 0.1µm 100-500µm 1µm	0 - 5mils 0.01mil 5-20mils 0.1mils	
NM3 Straight - 150mm	 T456FNM3---C							
NM3 45° Angle - 45mm	 T456NM3R45A							
NM3 45° Angle - 150mm	 T456NM3R45C							
NM3 Right Angle - 45mm	 T456NM3R90A							
NM3 Right Angle - 150mm	 T456NM3R90C							

¹ Accuracy: ±1% when calibrated close to the required thickness, ±3% across the range

Miniature Probe Specifications

Measuring Range	0 - 500µm (0 - 20mils)
Operating Temperature	Up to 150°C (300°F)
Accuracy ¹	±1-3% or ±2.5µm / ±1-3% or ±0.1mils (The accuracy quoted has been defined using a 100 micron foil, with the miniature probe held in a Probe)
Resolution	Below 100µm: 0.1µm, 100 - 500µm: 1µm Below 5mil: 0.01mil, 5 - 20mils: 0.1mil

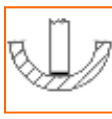
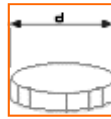
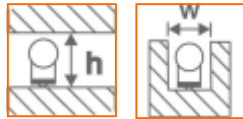
Probe Type†	Part Number					
		Minimum Convex Surface Diameter	Minimum Concave Surface Radius	Minimum Sample Diameter	Minimum Access Height	Re-Width
FERROUS MINIATURE PROBES						
Straight Probe, 45mm (1.77")	T456FM3---A	1.5mm (0.06")	6.5mm (0.26")	3mm (0.12")	6mm (0.24")	
Straight Probe, 150mm (5.90")	T456FM3---C	1.5mm (0.06")	6.5mm (0.26")	3mm (0.12")	6mm (0.24")	
45° Probe, 45mm (1.77")	T456FM3R45A	1.5mm (0.06")	6.5mm (0.26")	3mm (0.12")	18mm (0.71")	7mm (0.28")
45° Probe, 150mm (5.90")	T456FM3R45C	1.5mm (0.06")	6.5mm (0.26")	3mm (0.12")	18mm (0.71")	7mm (0.28")
90° Probe, 45mm (1.77")	T456FM3R90A	1.5mm (0.06")	6.5mm (0.26")	3mm (0.12")	16mm (0.63")	7mm (0.28")
90° Probe, 150mm (5.90")	T456FM3R90C	1.5mm (0.06")	6.5mm (0.26")	3mm (0.12")	16mm (0.63")	7mm (0.28")
NON-FERROUS MINIATURE PROBES						
Straight Probe, 45mm (1.77")	T456NM3---A	3mm (0.12")	25mm (0.98")	4mm (0.16")	6mm (0.24")	
Straight Probe, 150mm (5.90")	T456NM3---C	3mm (0.12")	25mm (0.98")	4mm (0.16")	6mm (0.24")	
45° Probe, 45mm (1.77")	T456NM3R45A	3mm (0.12")	25mm (0.98")	4mm (0.16")	18mm (0.71")	7mm (0.28")
45° Probe, 150mm (5.90")	T456NM3R45C	3mm (0.12")	25mm (0.98")	4mm (0.16")	18mm (0.71")	7mm (0.28")
90° Probe, 45mm (1.77")	T456NM3R90A	3mm (0.12")	25mm (0.98")	4mm (0.16")	16mm (0.63")	7mm (0.28")
90° Probe, 150mm (5.90")	T456NM3R90C	3mm (0.12")	25mm (0.98")	4mm (0.16")	16mm (0.63")	7mm (0.28")

¹ Accuracy: ±1% when calibrated close to the required thickness, ±3% across the range
 †Additional probe lengths are available upon request. For further information please contact Elcometer

Related products



Elcometer Digital Coating Accessories

Elcometer has a wide range of accessories for their coating thickness gauges, from larger handgrips for greater reading repeatability, to probe placement fixtures, portable printers to soft coatings adapters, Elcometer can help you achieve the maximum from your paint gauge.



Elcometer Standards and Calibration Foils

Formal quality systems such as those described in ISO 9000 and Guide 25 require that gauges be properly controlled, logged and in calibration. Increasingly, users are specifying that the readings taken by gauges are traceable to National Standards. There are three types of coating thickness standards available from Elcometer: coated standards, foils and zero test plates.



Elcometer 355

Accuracy, simplicity, versatility and flexibility are the watchwords of the Elcometer 355, a truly state of the art hand-held measuring system packed with time-saving and cost cutting features. The key to the superiority of the Elcometer 355 is its measuring system which features a range of interchangeable Probe Modules capable of an accuracy of $\pm 1\%$ of the reading on a variety of coatings and substrates.



Elcometer 365

The increased demand on coating performance has resulted in a need for greater control throughout the coating process. The Elcometer 365 has been designed to provide a controlled method of coating inspection - thereby allowing the user to monitor the coating process, statistically (SPC). The data generated by the Elcometer 365 can alert the operator to alter the process before the coating parameters have been exceeded, avoiding costly re-work.



Elcometer Inspection Kits

Site inspection requires a range of portable testing equipment. In order to make these products easily available and transportable, Elcometer have developed a range of Inspection Kits. All the gauges are conveniently stored in one hard plastic protective carrying case and are supplied with full operating instructions.

ENGLAND

Elcometer Instruments Ltd
Edge Lane
Manchester M43 6BU

Tel: +44 (0) 161 371 6000
Fax: +44 (0) 161 371 6010
e-mail: sales@elcometer.com
www.elcometer.com

USA

Elcometer Instruments Inc
1893 Rochester Industrial Drive
Rochester Hills Michigan 48309

Tel: +1 248 650 0500
Toll free: 800 521 0635
Fax: +1 248 650 0501
e-mail: inc@elcometer.com
www.elcometer.com

CANADA

Elcometer Canada Ltd
PO Box 622, 401 Ouelette Avenue
Windsor, Ontario N9A 6N4

Tel: +1 248 650 0500
Toll Free: 800 521 0635
Fax: +1 248 650 0501
e-mail: ca_info@elcometer.com
www.elcometer.com

ASIA & THE FAR EAST

Elcometer (Asia) Pte Ltd
896 Dunearn Rd
Sime Darby Centre #3-09
Singapore 589472,
Republic of Singapore

Tel: +65 6462 2822
Fax: +65 6462 2860
e-mail: asia@elcometer.com
www.elcometer.com

BELGIUM

Elcometer SPRL
Rue Vallée 13
B-4681 Hermalle /s Argenteau

Tel: +32 (0)4 379 96 10
Fax: +32 (0)4 374 06 03
e-mail: be_info@elcometer.be
www.elcometer.be

FRANCE

Elcometer SARL
BP 8-Bou
60 Rue de la Petite Levée
45430 Chécy

Tel: +33 (0)2 38 86 33 44
Fax: +33 (0)2 38 91 37 66
e-mail: fr_info@elcometer.fr
www.elcometer.fr

GERMANY

Elcometer Instruments GmbH
Himmlingstraße 18
D-73434 Aalen

Tel: +49 (0) 7366 91 92 83
Fax: +49 (0) 7366 91 92 86
e-mail: de_info@elcometer.de
www.elcometer.de